



WHITE-RODGERS

1F87-51

Programmable Electronic Digital Thermostat

**INSTALLATION AND
OPERATION INSTRUCTIONS**

Operator: Save these instructions for future use!

**FAILURE TO READ AND FOLLOW ALL INSTRUCTIONS CAREFULLY
BEFORE INSTALLING OR OPERATING THIS CONTROL COULD CAUSE
PERSONAL INJURY AND/OR PROPERTY DAMAGE.**

DESCRIPTION

Your new White-Rodgers 7-Day Digital Thermostat uses the technology of a solid-state microcomputer to provide precise time/temperature control. This thermostat offers you the flexibility to design heating and cooling programs that fit your needs.

Features:

- Battery powered (3 "AA" Energizer® alkaline batteries included).
- Separate program for each day of the week
- Simultaneous heat and cool program storage
- Preprogrammed temperature control
- Four separate time/temperature settings per 24-hour period

- LCD continuously displays set point, and alternately displays time and room temperature
- Temperature override until next program period
- Manual program override (HOLD temperature)
- User may select either 12- or 24-hour clock display
- °F/°C convertibility
- Temperature range 45° to 90°F
- Standard five terminals for single or two-transformer systems
- B and O terminals for single stage heat pumps or damper operation

PRECAUTIONS

This thermostat is intended for use with a low voltage system; do not use this thermostat with a line voltage system. If in doubt about whether your wiring is millivolt, line, or low voltage, have it inspected by a qualified heating and air conditioning contractor or electrician.

Do not exceed the specification ratings.

All wiring must conform to local and national electrical codes and ordinances.

This control is a precision instrument, and should be handled carefully. Rough handling or distorting components could cause the control to malfunction.

⚠ CAUTION

To prevent electrical shock and/or equipment damage, disconnect electric power to system at main fuse or circuit breaker box until installation is complete.

⚠ WARNING

Do not use on circuits exceeding specified voltage. Higher voltage will damage control and could cause shock or fire hazard.

Do not short out terminals on gas valve or primary control to test. Short or incorrect wiring will damage thermostat and could cause personal injury and/or property damage.

SPECIFICATIONS

ELECTRICAL DATA

Electrical Rating:

- 8 to 30 VAC 50/60 Hz. or D.C.
- 0.05 to 1.5 Amps (Load per terminal)
- 1.5 Amps Maximum Total Load** (All terminals combined)

THERMAL DATA

Setpoint Temperature Range:

45°F to 90°F (7°C to 32°C)

Operating Ambient Temperature Range:

32°F to 105°F

Operating Humidity Range:

0 to 90% RH (non-condensing)

Shipping Temperature Range:

-40°F to 150°F

APPLICATIONS

For use with:

- Standard heat/cool or heat only systems
- Electric heat systems
- Gas or oil fired systems
- Gas systems with Intermittent Ignition Devices (I.I.D.) and/or vent dampers
- Hydronic (hot water or steam) systems
- Single-stage heat pump systems
- Millivolt systems

DO NOT USE WITH:

- Multi-stage systems
- Systems exceeding 30 VAC and 1.5 amps
- 3-wire zoned hydronic heating systems



WHITE-RODGERS DIVISION
EMERSON ELECTRIC CO.
9797 REAVIS ROAD
ST. LOUIS, MISSOURI 63123-5398

Printed in U.S.A.

PART NO. 37-5323E
Replaces 37-5323D
0004

INSTALLATION

REMOVE OLD THERMOSTAT

1. Shut off electricity at the main fuse box until installation is complete. Ensure that electrical power is disconnected.
2. Remove the front cover of the old thermostat. **With wires still attached**, remove wall plate from the wall. If the old thermostat has a wall mounting plate, remove the thermostat and the wall mounting plate as an assembly.
3. **Identify each wire attached to the old thermostat using the labels enclosed with the new thermostat.**
4. Disconnect the wires from old thermostat one at a time. **DO NOT LET WIRES FALL BACK INTO THE WALL.**
5. Install new thermostat using the following procedures.

ELECTRIC HEAT OR SINGLE-STAGE HEAT PUMP SYSTEMS

Read entire paragraph before setting electric heat switch. If you are unsure of your application, contact a qualified serviceperson.

If you have a single-stage heat pump system, OR your system uses central electric heat, where the blower is energized by a **separate circuit** through the fan relay (meaning that the fan turns on immediately on call for heat), then the switch on the back of the thermostat base must be moved to the “ELECTRIC” position (see fig 1). If the thermostat is energizing electric heat sequencers, the switch **MUST** remain in the “GAS” position.

If you must move the switch to the “ELECTRIC” position (to the left), use a small screwdriver or pencil.

ATTACH THERMOSTAT BASE TO WALL

1. Remove the packing material from the thermostat. Gently pull the cover straight off the base. Forcing or prying on the thermostat will cause damage to the unit. If necessary, move the electric heat switch (see **ELECTRIC HEAT SYSTEMS**, above).
2. Connect wires beneath terminal screws on base using appropriate wiring schematic (see figs. 3 through 10).
3. Place base over hole in wall and mark mounting hole locations on wall using base as a template.
4. Move base out of the way. Drill mounting holes.
5. Fasten base loosely to wall, as shown in fig. 2, using two mounting screws. Place a level against bottom of base, adjust until level, and then tighten screws. (Leveling is for appearance only and will not affect thermostat operation.) If you are using existing mounting holes, or if holes drilled are too large and do not allow you to tighten base snugly, use plastic screw anchors to secure subbase.
6. Push excess wire into wall and plug hole with a fire-resistant material (such as fiberglass insulation) to prevent drafts from affecting thermostat operation.

BATTERY LOCATION

This thermostat requires 3 “AA” alkaline batteries to operate. Batteries are installed in the thermostat at the factory with a battery tag to prevent power drainage. **You must remove the battery tag to engage the batteries and provide power to the thermostat.**

If the word **BATTERY** is displayed, the batteries are low and should be replaced with fresh “AA” Energize® alkaline batteries. To replace batteries, install the batteries along the top of the base (see fig. 2). The batteries must be installed with the positive (+) ends to the left.

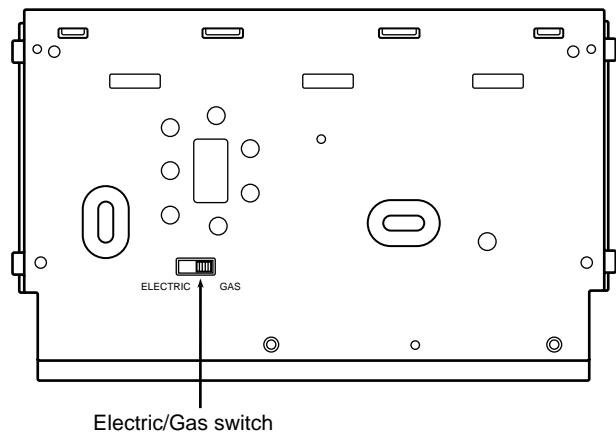

Figure 1. Back of thermostat base

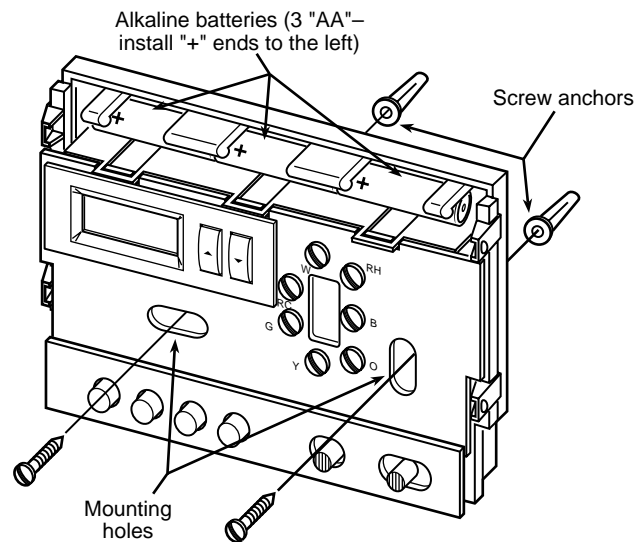

Figure 2. Thermostat base

HYDRONIC (HOT WATER OR STEAM) HEATING SYSTEMS

This thermostat is set to operate properly if you have a forced-air heating system. If you have a hydronic heating system (a system that heats with hot water or steam), you must set the thermostat to operate properly with your system. While in the HEAT mode, change the setting by pressing SET TIME/SET TEMP and VIEW PRGM buttons at the same time until the correct setting is displayed (**A** for forced air; **H** for hydronic systems). If there is a loss of battery power, or when you change batteries, you must repeat this operation once battery power is restored.

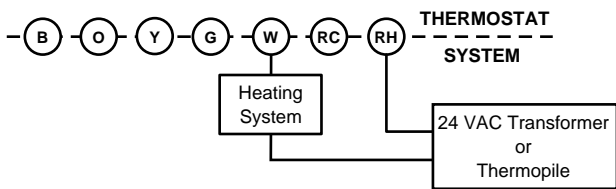

Figure 3. Typical wiring diagram for heating only, 2-wire, single transformer systems or millivolt systems

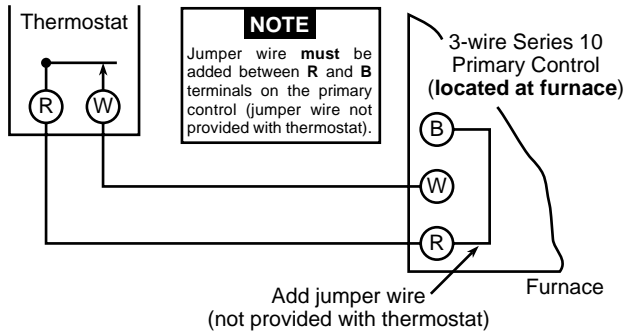

Figure 4. Typical wiring diagram for 3-wire SERIES 10 heating systems

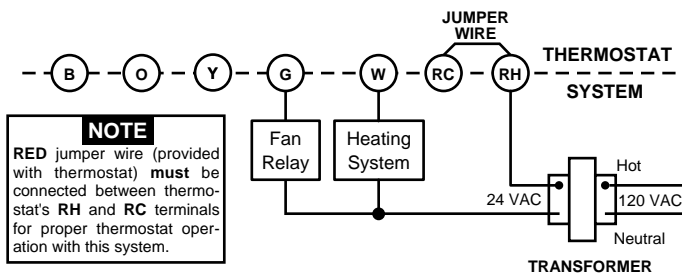

Figure 5. Typical wiring diagram for heat only, 3-wire, single transformer systems

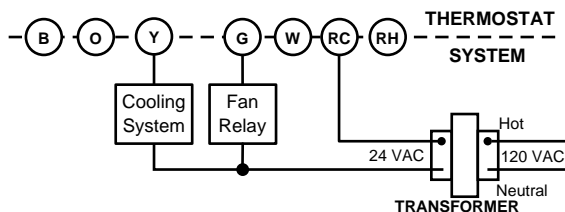

Figure 6. Typical wiring diagram for cool only, 3-wire, single transformer systems

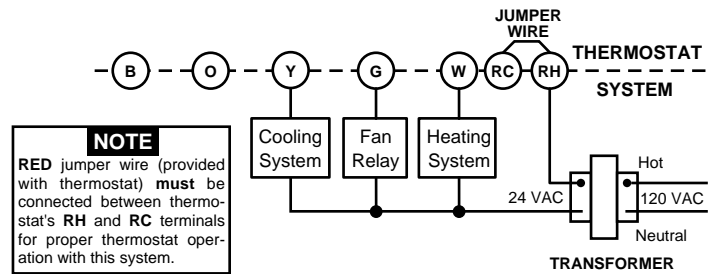

Figure 7. Typical wiring diagram for heat/cool, 4-wire, single transformer systems

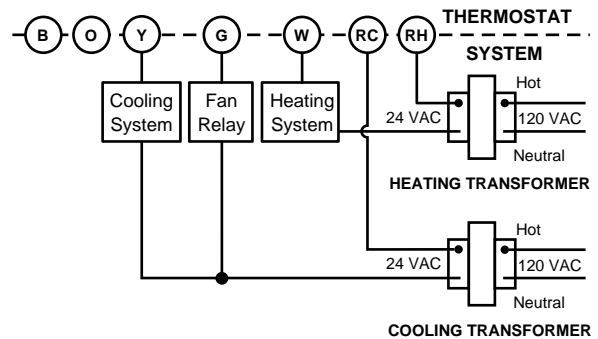
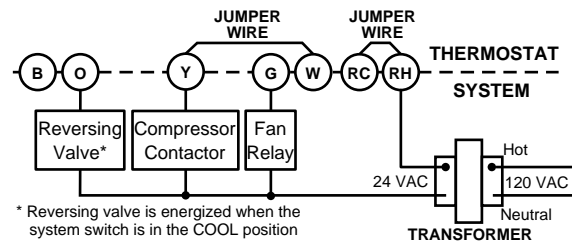
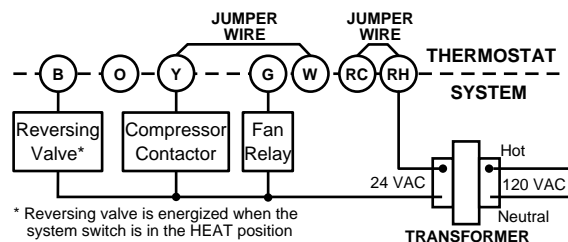

Figure 8. Typical wiring diagram for heat/cool, 5-wire, two-transformer systems



* Reversing valve is energized when the system switch is in the COOL position

Figure 9. Typical wiring diagram for heat pump with cool active reversing valve



* Reversing valve is energized when the system switch is in the HEAT position

Figure 10. Typical wiring diagram for heat pump with heat active reversing valve

CHECK THERMOSTAT OPERATION



If at any time during testing your system does not operate properly, contact a qualified serviceperson.

Fan Operation

If your system **does not** have a **G** terminal connection, skip to **Heating System**.

1. Turn on power to the system.
2. Move FAN switch to **ON** position. The blower should begin to operate.
3. Move FAN switch to **AUTO** position. The blower should stop immediately.

Heating System



1. Move SYSTEM switch to **HEAT** position. If the heating system has a standing pilot, be sure to light it.
2. Press  to adjust thermostat setting above room temperature. The heating system should begin to operate.
3. Press  to adjust temperature setting below room temperature. The heating system should stop operating.

Cooling System

This thermostat has a built-in short-term (5-minute) time delay. This feature is activated after the compressor shuts down and the setpoint is changed within the 5-minute period. During this 5-minute period, COOL will flash on the display indicating that the thermostat has locked out the compressor to allow head pressure to stabilize. This thermostat does not sense AC power loss and therefore does not activate the short term compressor protection feature when power is restored.

⚠ CAUTION



To prevent compressor and/or property damage, if the outdoor temperature is below 50°F, DO NOT operate the cooling system.

1. Move SYSTEM switch to **COOL** position.
2. Press  to adjust thermostat setting below room temperature. The blower should come on immediately on high speed, followed by cold air circulation
3. Press  to adjust temperature setting above room temperature. The cooling system should stop operating.

OPERATION

Before you begin programming your thermostat, you should be familiar with its features and with the display and the location and operation of the thermostat buttons. Your thermostat consists of two parts: the **thermostat cover** and the **base**. To remove the cover, gently pull it straight out from the base. To replace the cover, line up the cover with the base and press gently until the cover snaps onto the base.

THE THERMOSTAT BASE

Other than  and , the following buttons and switches are located behind the door on the bottom of the thermostat cover (see fig. 11). Pull the door down to open it.

The Thermostat Buttons and Switches

- ① (Red arrow) Raises temperature setting.
- ② (Blue arrow) Lowers temperature setting.
- ③ SET TIME/SET TEMP button.
- ④ VIEW PRGM (program) button.
- ⑤ RUN PRGM (program) button.
- ⑥ HOLD TEMPerature/ADVance DAY button.
- ⑦ FAN switch (**ON**, **AUTO**).
- ⑧ SYSTEM switch (**COOL**, **OFF**, **HEAT**).

The Display

- ⑨ Indicates day of the week.
- ⑩ **HEAT** is displayed when the SYSTEM switch is in the HEAT position. **COOL** is displayed (non-flashing) when the SYSTEM switch is in the COOL position. **COOL** is displayed (flashing) when the compressor is in lockout mode.

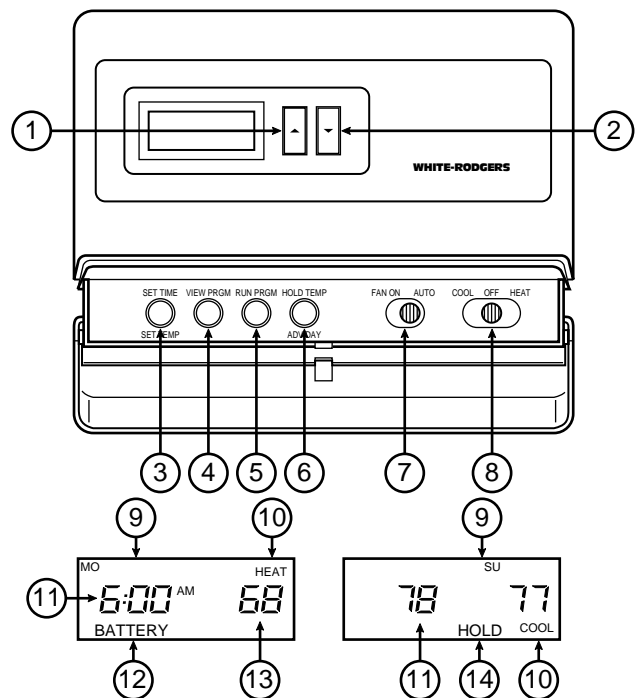







Figure 11. Thermostat display, buttons, and switches

- ⑪ Alternately displays current time and temperature.
- ⑫ **BATTERY** is displayed when the 3 "AA" batteries are low and should be replaced. Nothing else will be displayed.
- ⑬ Displays currently programmed set temperature (this is blank when SYSTEM switch is in the OFF position).
- ⑭ The word **HOLD** is displayed when the thermostat is in the HOLD mode.

OPERATING FEATURES

Now that you are familiar with the thermostat buttons and display, read the following information to learn about the many features of the thermostat.

- **SIMULTANEOUS HEATING/COOLING PROGRAM STORAGE** — When programming, you can enter both your heating and cooling programs at the same time. There is no need to reprogram the thermostat at the beginning of each season.
- **TEMPERATURE OVERRIDE** — Press  or  until the display shows the temperature you want. The thermostat will override current programming and keep the room temperature at the selected temperature until the next program period begins. Then the thermostat will automatically revert to the program.
- **HOLD TEMPERATURE** — The thermostat can hold any temperature within its range for an indefinite period, without reverting to the programmed temperature. Press HOLD TEMP/ADV DAY button. **HOLD** will be displayed. Then choose the desired hold temperature by pressing  or . The thermostat will hold the room temperature at the selected setting until you press RUN PRGM button to start program operation again.
- **°F/°C CONVERTIBILITY** — Press SET TIME/SET TEMP and HOLD TEMP/ADV DAY buttons until the temperature display is in Celsius (°C). To display Fahrenheit (°F), repeat the process.
- **12-HOUR/24-HOUR CLOCK DISPLAY** — The clock is set to display 12-hour time, which means that the clock will display AM and PM time (12:00 AM is midnight; 12:00 PM is noon). However, you may want to display a 24-hour clock (military-style time). The 24-hour clock display will show 1:00 PM as 13:00, 2:00 PM as 14:00, and so on. To change to the 24-hour clock display, press SET TIME/SET TEMP and RUN PRGM buttons at the same time. In the 24-hour clock mode, AM and PM are not displayed.
- **LOW BATTERY INDICATOR** — If the 3 “AA” alkaline batteries are low and should be replaced, the display will be blank except for the word **BATTERY**. When the batteries are low, pressing any button will cause the display to operate for ten seconds. After ten seconds, the display will be blank except for the word **BATTERY**. You cannot program with low batteries, but you can override setpoint temperature.
- **TEMPERATURE DISPLAY ADJUSTMENT** — Your new thermostat has been accurately set in our factory. However, if you wish, you may adjust your new thermostat temperature display to match your old thermostat. This can be accomplished (within a $\pm 4^\circ$ range) as follows:
 1. Press VIEW PRGM and HOLD TEMP/ADV DAY buttons at the same time.
 2. Press  or  to adjust the displayed temperature to your desired setting.
 3. Press RUN PRGM to resume normal program operation.
- **COPY DAY FUNCTION** — This feature allows Monday’s program to be copied into the rest of the week’s programming. **This feature is only available the first time you program your thermostat.** To use this feature, simply enter the program for Monday as described in PROGRAMMING YOUR THERMOSTAT, and then press RUN PRGM.

PROGRAMMING YOUR THERMOSTAT

Now you are ready to program your thermostat. This section will help you plan your thermostat’s program to meet your needs. For maximum comfort and efficiency, keep the following guidelines in mind when planning your program.

- When heating (cooling) your building, program the temperatures to be cooler (warmer) when the building is vacant or during periods of low activity.
- During early morning hours, the need for cooling is usually minimal.

Look at the factory preprogrammed times and temperatures shown below. If this program will suit your needs, simply press the RUN PRGM button to begin running the factory preset program.

FACTORY PREPROGRAMMING					
Heating Program for ALL days of the Week:			Cooling Program for ALL Days of the Week:		
PERIOD	TIME	TEMP	PERIOD	TIME	TEMP
1st	6:00 AM	68°F	1st	6:00 AM	78°F
2nd	8:00 AM	68°F	2nd	8:00 AM	82°F
3rd	5:00 PM	68°F	3rd	5:00 PM	78°F
4th	10:00 PM	64°F	4th	10:00 PM	78°F

If you want to change the preprogrammed times and temperatures, follow these steps.

1. Determine the heating and cooling temperatures you want to use. You may select up to four heating temperatures (**HEAT 1, HEAT 2, HEAT 3, and HEAT 4**), and up to four cooling temperatures (**COOL 1, COOL 2, COOL 3, and COOL 4**). Use the table below to write down the temperatures you have selected.

	Heat Temperatures				Cool Temperatures			
	1	2	3	4	1	2	3	4
Your selected temperatures*								
Factory pre-programmed temperatures*	68°F	68°F	68°F	64°F	78°F	82°F	78°F	78°F

* You may only program heating temperatures you have selected into the heating program and cooling temperatures into the cooling program (for example, you cannot program the COOL 1 temperature into your heating program). You may program the temperatures you choose in any order, and you may use the same temperature in consecutive program periods (for example, you may program period 1 with temperature 1 and periods 2, 3, and 4 with temperature 2). You do not have to use all possible temperature choices (for example, you may want to select temperatures for HEAT 1 and HEAT 2 only – in this case, the HEAT 3 and HEAT 4 temperatures would stay the same as previously programmed).

2. Determine the time periods during which you will program the temperatures you have just selected. You must program four periods for each day (periods 1, 2, 3, and 4). However, you may use the same heating and cooling temperatures for consecutive time periods. Also keep in mind that, for any given day, you can only program one set of times for both heating and cooling (for example, if you select 5:00 AM to begin heating period 1 on Monday, then your cooling period 1 for Monday will also begin at 5:00 AM). However, you may select different time periods for each day separately (for example, heating/cooling period 1 on Monday may begin at 5:00 AM, but heating/cooling period 1 on Saturday may begin at 9:00 AM). Use the table on the following page to plan your program time periods, and the temperatures you want during each period. You may also want to look at the sample program table to get an idea of how the thermostat can be programmed.

Heating/Cooling Schedule Plan

THIS THERMOSTAT ALLOWS ONE SET OF TIMES FOR BOTH HEATING AND COOLING

	Period 1			Period 2			Period 3			Period 4		
	Time	Heat Temp.	Cool Temp.	Time	Heat Temp.	Cool Temp.	Time	Heat Temp.	Cool Temp.	Time	Heat Temp.	Cool Temp.
Monday												
Tuesday												
Wednesday												
Thursday												
Friday												
Saturday												
Sunday												

SAMPLE Heating/Cooling Schedule Plan

HEAT 1 = 65° COOL 1 = 80°
 HEAT 2 = 68° COOL 2 = 78°
 HEAT 3 = 70° COOL 3 = 76°
 HEAT 4 = 72° COOL 4 = 74°

THIS THERMOSTAT ALLOWS ONE SET OF TIMES FOR BOTH HEATING AND COOLING

	Period 1			Period 2			Period 3			Period 4		
	Time	Heat Temp.	Cool Temp.	Time	Heat Temp.	Cool Temp.	Time	Heat Temp.	Cool Temp.	Time	Heat Temp.	Cool Temp.
Monday	5:00 AM	65° (1)	80° (1)	9:00 AM	65° (1)	80° (1)	3:30 PM	65° (1)	80° (1)	11:30 PM	65° (1)	80° (1)
Tuesday	6:00 AM	65° (1)	80° (1)	8:00 AM	70° (3)	76° (3)	4:30 PM	72° (4)	74° (4)	10:30 PM	65° (1)	80° (1)
Wednesday	5:00 AM	65° (1)	80° (1)	9:00 AM	70° (3)	76° (3)	3:30 PM	72° (4)	74° (4)	11:30 PM	65° (1)	80° (1)
Thursday	5:00 AM	65° (1)	80° (1)	9:00 AM	70° (3)	76° (3)	5:30 PM	72° (4)	74° (4)	11:30 PM	65° (1)	80° (1)
Friday	5:00 AM	65° (1)	80° (1)	9:00 AM	70° (3)	76° (3)	3:30 PM	72° (4)	74° (4)	10:30 PM	65° (1)	80° (1)
Saturday	8:00 AM	65° (1)	80° (1)	10:00 AM	70° (3)	76° (3)	3:30 PM	72° (4)	74° (4)	11:30 PM	65° (1)	80° (1)
Sunday	8:00 AM	70° (3)	78° (2)	9:00 AM	70° (3)	76° (3)	3:30 PM	68° (2)	76° (3)	9:30 PM	65° (1)	80° (1)



Entering Your Program

Follow these steps to enter the heating and cooling programs you have selected.



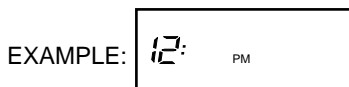

Set Current Time and Day

1. Press SET TIME/SET TEMP button once. The display will show the hour only.



2. Press and hold either  or  until you reach the correct hour and AM/PM designation (**AM** begins at midnight; **PM** begins at noon).
3. Press SET TIME/SET TEMP once. The display window will show the minutes only.







4. Press and hold either  or  until you reach the correct minutes.
5. Press SET TIME/SET TEMP once. The display will show the day of the week.
6. Press  or  until you reach the current day of the week.
7. Press RUN PRGM once. The display will show the correct time and room temperature alternately.

Select Heating Temperatures

1. If you want to change the display from Fahrenheit to Celsius (or vice-versa), press SET TIME/SET TEMP and HOLD TEMP/ADV DAY at the same time.
2. Move the SYSTEM switch to **HEAT**.
3. Press SET TIME/SET TEMP four times. The display will show the number 1, along with the currently programmed **HEAT 1** temperature.







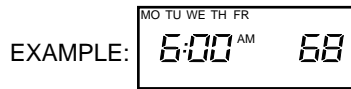

4. Press  or  to change the displayed temperature to your selected **HEAT 1** setting (if you only want to program a temperature for **HEAT 1**, skip to step 8).
5. Press SET TIME/SET TEMP once. The number **1** will change to the number **2**, representing **HEAT 2**.
6. Press  or  until you reach your selected **HEAT 2** temperature.
7. Repeat steps 5 and 6 to select **HEAT 3** and **HEAT 4** temperature settings, if desired.
8. Press RUN PRGM.
8. Press HOLD TEMP/ADV DAY once. **TU** (indicating Tuesday's program) will be displayed, along with the start time for the 1st heating/cooling period and the currently programmed heating setpoint temperature.
9. Repeat steps 3 through 7 to complete Tuesday's heating program.
10. Continue entering each day's programming until all heating/cooling periods and heating temperatures have been selected.
11. Press RUN PRGM to end heating programming. Proceed to the **SELECT COOLING TEMPERATURES** section.

Enter Heating/Cooling Times and Heating Temperatures

1. Move the SYSTEM switch to **HEAT**.
2. Press VIEW PRGM once. **MO**, the abbreviation for Monday, will be displayed. Also displayed are the currently programmed start time for the 1st heating/cooling period and the currently programmed **HEAT 1, 2, 3, or 4** temperature for the 1st heating/cooling period (flashing).







This example display shows that for the 1st Monday heating/cooling period, the start time is 6:00 AM, and 68° is the programmed temperature (this example reflects factory pre-programming).

3. If the temperature displayed is not the **HEAT 1, 2, 3, or 4** temperature you want for Monday's period 1, press  or  until the correct temperature is displayed (if you keep pressing  or , the **HEAT 1, 2, 3, and 4** temperatures you previously programmed will be alternately displayed).
4. To change the displayed start time to the time you have selected for Monday's heating/cooling period 1, press SET TIME/SET TEMP once (the programmed time will flash). Press  or  until your selected time is displayed. The time will change in 30-minute increments. **The time that you program will be the start time of Monday's period 1 for both heating and cooling.** After selecting the correct period 1 start time, press SET TIME/SET TEMP again to return to the change temperature mode.
5. Press VIEW PRGM once. The currently programmed start time and heating setpoint temperature for Monday's heating/cooling period 2 will be displayed.
6. Repeat steps 3 and 4 to select the start time and heating temperature for Monday's 2nd heating/cooling period.
7. Repeat steps 3 through 5 for Monday's 3rd and 4th heating/cooling period. Monday's heating program is now complete.

NOTE

If you are programming your thermostat for the first time, and you want programming for all days of the week to be the same as Monday's program, press RUN PRGM at this point, and proceed to the **SELECT COOLING TEMPERATURES** section (this COPY DAY feature only works the first time you program your thermostat; if you are changing your thermostat's programming, you must program each day separately).





Select Cooling Temperatures

1. Move the SYSTEM switch to **COOL**.
2. Press SET TIME/SET TEMP four times. The display will show the number **1**, along with the currently programmed **COOL 1** temperature.
3. Press  or  to change the displayed temperature to your selected **COOL 1** setting (if you only want to program a temperature for **COOL 1**, skip to step 7).
4. Press SET TIME/SET TEMP once. The number **1** will change to the number **2**, representing **COOL 2**.
5. Press  or  until you reach your selected **COOL 2** temperature.
6. Repeat steps 4 and 5 to select **COOL 3** and **COOL 4** temperature settings, if desired.
7. Press RUN PRGM.

Enter Cooling Temperatures

CAUTION

If the outside temperature is below 50°F, disconnect power to the cooling system before programming. Energizing the air conditioner compressor during cold weather may cause personal injury or property damage.

1. Move SYSTEM switch to **COOL** position.
2. Press VIEW PRGM once. **MO**, the abbreviation for Monday, will be displayed. Also displayed are the start time you previously programmed for the 1st heating/cooling period and the currently programmed **COOL 1, 2, 3, or 4** temperature for the 1st heating/cooling period (flashing). **Remember that the time you previously selected is for both heating and cooling periods. If you change a programmed start time now, it will also change the start time for the heating program.**
3. If the temperature displayed is not the **COOL 1, 2, 3, or 4** temperature you want for Monday's period 1, press  or  until the correct temperature is displayed (if you keep pressing  or , the **COOL 1, 2, 3, and 4** temperatures you previously programmed will be alternately displayed).
4. Press VIEW PRGM once. The currently programmed start time and cooling setpoint temperature for Monday's heating/cooling period 2 will be displayed.
5. Repeat step 3 to select the cooling temperature for Monday's 2nd heating/cooling period.
6. Repeat steps 3 and 4 for Monday's 3rd and 4th heating/cooling period. Monday's cooling program is now complete.

(Programming instructions continue on next page.)

NOTE

If you are programming your thermostat for the first time, and you want programming for all days of the week to be the same as Monday's program, press RUN PRGM to begin program operation (this COPY DAY feature only works the first time you program your thermostat; if you are changing your thermostat's programming, you must program each day separately).

7. Press HOLD TEMP/ADV DAY once. **TU** (indicating Tuesday's program) will be displayed, along with the start time for the 1st heating/cooling period and the currently programmed cooling setpoint temperature.
8. Repeat steps 3 through 6 to complete Tuesday's cooling program.
9. Continue entering each day's programming until all cooling temperatures have been selected.
10. Press RUN PRGM to end programming and begin program operation.

CHECK YOUR PROGRAMMING

Follow these steps to check your thermostat programming one final time before beginning thermostat operation.

1. Move SYSTEM switch to **HEAT** position.
2. Press VIEW PRGM to view the 1st Monday heating period time and temperature. Each time you press VIEW PRGM, the next heating period time and temperature for Monday will be displayed in sequence. Press HOLD/ADV DAY to display Tuesday's 1st heating period program. Press VIEW PRGM to check the remaining Tuesday heating period times and temperatures. To check each day's heating program, press HOLD TEMP/ADV DAY to change days, then press VIEW PRGM to look at each programming period for the day (you may change any time or temperature during this procedure; remember that if you change the start time, it changes for both heating and cooling).
3. Press RUN PRGM.
4. Move SYSTEM switch to **COOL** position.
5. Repeat step 2 to check cooling temperatures.
6. Press RUN PRGM to begin program operation.

YOUR THERMOSTAT IS NOW COMPLETELY PROGRAMMED AND READY TO AUTOMATICALLY PROVIDE MAXIMUM COMFORT AND EFFICIENCY!